

Premium Commercial Tunable Downlight with optional Integrated Emergency Battery



3000K

4000K

5000K



Intertek

ETL CLASSIFIED



Intertek



Product Description:

The E2-DL series is an Premium Tunable Commercial Downlight, Ideal for school, hospital, retail, office and other retrofit and new construction applications.

Features

1. 4" ,6" & 8" Recessed Emergency downlight
2. AC100-277V input voltage
3. All in one driver CCT & wattage tunable
4. 3 Wattage & 3 CCT Tunable (5 CCT in EBBU)
5. 10W Emergency power 1000lm 90mins
6. 100LPW and > 90 CRI
7. 0-10V Dim with 12V (for sensor)
8. Aluminum housing and heat-sink
9. ETL & ES certification

Physical Dimensions

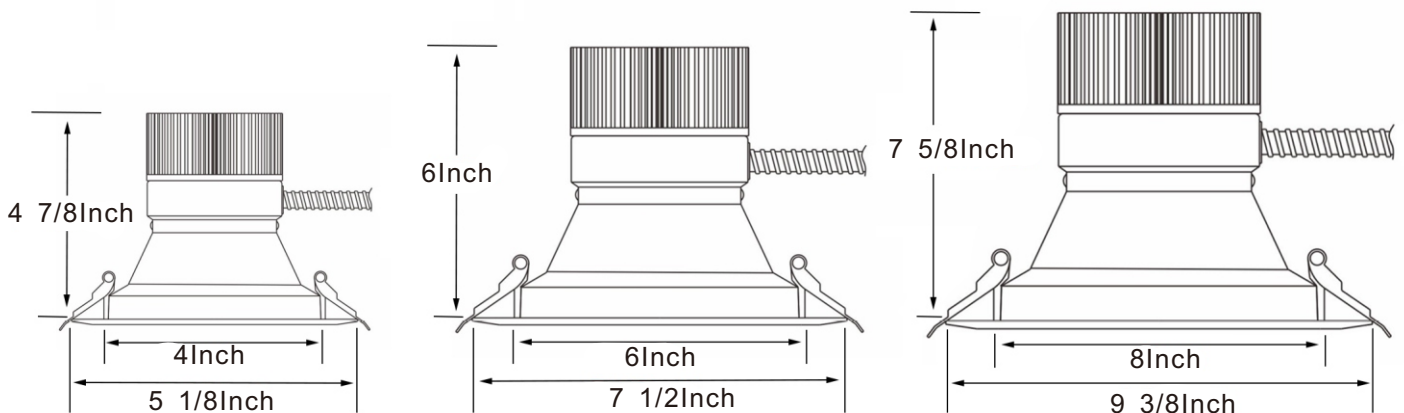

Specifications

Size	4INCH		6INCH			8INCH		
Model	DL4-20	DL4-24E	DL6-40	DL6-24E	DL6-40E	DL8-40	DL8-24E	DL8-40E
Voltage	AC-100-277V							
Power	10/15/20W	16/20/24W	20/30/40W	16/20/24W	20/30/40W	20/30/40W	16/20/24W	20/30/40W
lumens	1000-2000 lm	1600-2400 lm	2000-4000 lm	1600-2400 lm	2000-4000 lm	2000-4000 lm	1600-2400 lm	2000-4000 lm
E-Power	NO	10W	NO	10W	10W	NO	10W	10W
E-Lumen		900-1000 lm		900-1000 lm	900-1000 lm		900-1000 lm	900-1000 lm
CCT	30/40/50K	27/30/35/40/50K	30/40/50K	27/30/35/40/50K	30/40/50K	30/40/50K	27/30/35/40/50K	30/40/50K
CRI	>90							

J-Box dimension

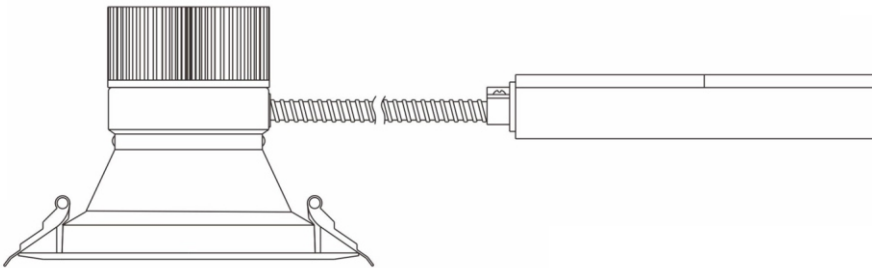

J-box Size

Length: 9.25Inch

Width: 3.4Inch

Thickness: 1.37Inch

Wattage & CCT Adjustment

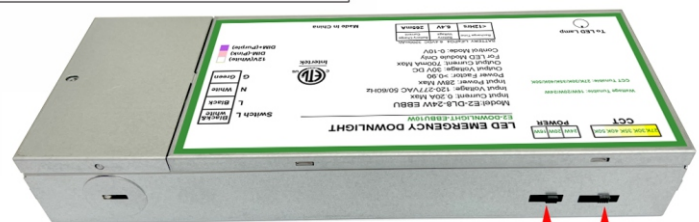
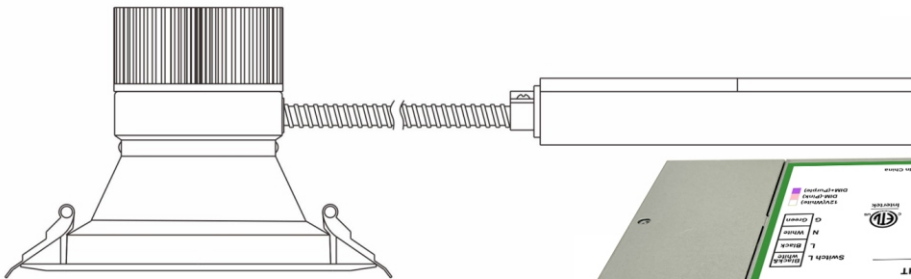

Power Select

CCT Select

Wiring Diagram

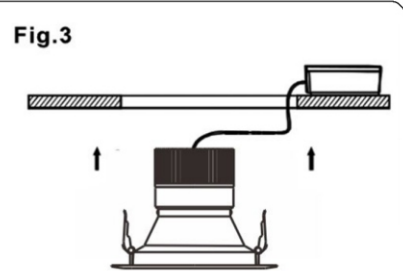
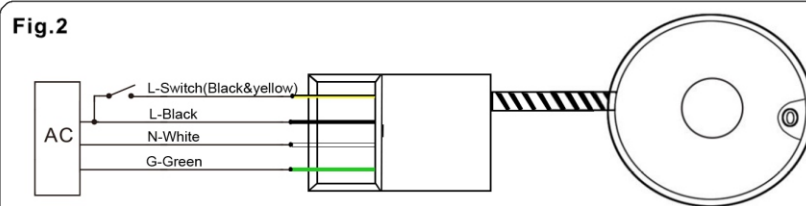
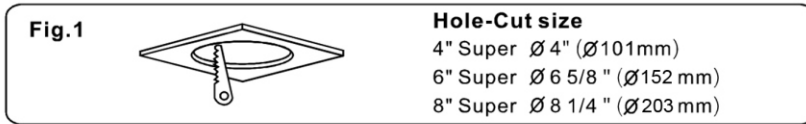

CAUTIONS:
 Please read this manual carefully before installing emergency panel.
 Please turn off AC power before rewiring and installation.
Ensure that L and N of the panel are properly connected to L and N of the AC power supply!



AC Operation

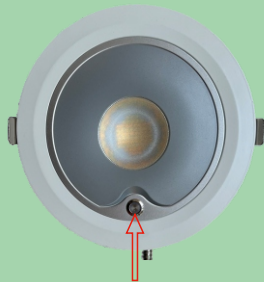

Test Button & LED Indicator

1. LED Indicator on when EBBU Mode
2. LED Indicator Slow flicker when Charging
3. LED Indicator quick flicker when EBBU issue (self-inspection function)
4. Press down the test button, turn to EBBU Mode Release the Test Button, Turn To AC Mode



When using electrical equipment, basic safety precautions should always be followed including the following:

READ AND FOLLOW ALL SAFETY INSTRUCTIONS.

1. After getting the lamp, do not hurry to install it. Please read the installation and use safety instructions, and install and use the lamp according to the instructions.
2. Before installing, make certain the AC power to the fixture is off.
3. Do not use outdoors.
4. Do not let the lamp touch hot surfaces.
5. Do not mount near gas or electric heaters.
6. Repairs and maintenance must be carried out by qualified personnel.
7. In this reminder, do not frequently switch the power supply when the lamp is in use. Since the lamp is frequently started at all times, the current is passed through the light source, Higher than normal working current, making the light source heating violently, thus reducing the service life.



WARNING: RISK OF SHOCK, House electric current can cause painful shock or serious injury unless handled properly.

CAUTION: Turn off the main power at the circuit breaker before installing, in order to prevent possible shock