

NEW

E2-DL-SLIM-E G2 Series Ultra Slim Gen2 Down Light with Pre-Wired Battery Back-Up

The Ultra Slim LED Tunable Down Light, Up to 71 lm/W, IP54 Wet Location, Select 5X-CCT (2700K, 3000K, 3500K, 4000K, 5000K) and Wattage tunable, both Tri Dimming and 0-10V Dimming, Premium Indoor Luminaire.



Test Switch



Charging Indicator

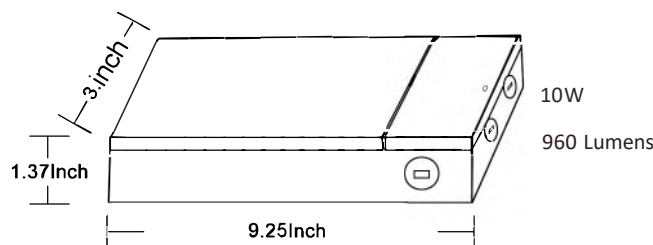
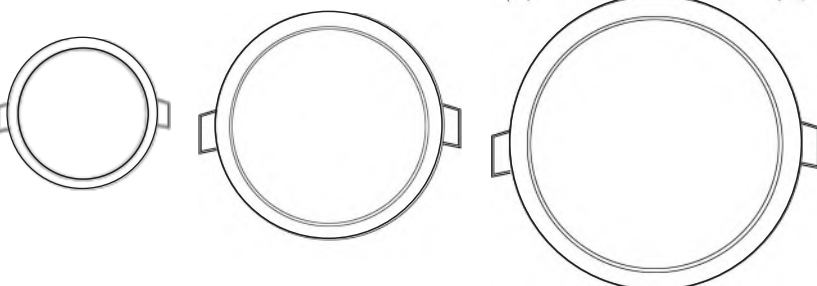
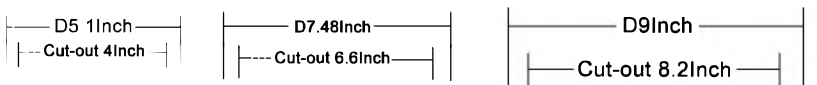

PRODUCT DESCRIPTION:

The E2 Ultra Slim LED Downlight with Emergency Battery Backup is a Recessed Down Light Can and all Conduit cable connection.

This is IC rated for direct installation; so, mounted cans are not in the ceiling. Its ultra thin profile allows you to quickly install into almost any location with its two pressure fit clips.

The E2 Down Lights are suitable for damp locations and soffit installations, which is perfect for limited space locations.

Offering both Tri Dimming and 0-10V Dimming allows for great installation flexibility.

FEATURES AND STANDARDS:

- Lumen Output 639 to 1278 lumens
- 10W rechargeable battery for 90 mins plus
- Efficacy Up to 71 lm/W
- Input Voltage 120-277V
- Dimmable 0-10V and Tri Dimming and (12V AUX)
- CCT Select (2700K, 3000K, 3500K, 4000K, 5000K)
- IP Rating IP54 Wet Location
- Size 4- in, 6-in, 8-in
- Warranty 5 Years

APPLICATION:

Premium indoor luminaire for recessed mounting in ceiling spaces. Suitable for general indoor, lobbies, offices, meeting rooms, restrooms, hallways, hospitals, airports, hotels, restaurants and shopping centers.

TESTED DATA:

Input Voltage: 120-277V
 Input Frequency: 50/60 Hz
 Wattage: 4-inch 9W
 Wattage: 6-inch Tunable 9W / 16W / 18W
 Wattage: 8-inch 9W / 16W / 18W
 Power Factor: >0.9
 Total Harmonic Distortion (THD): <20%
 Operating Temperature: -4°F to 104°F

Product Number	Wattage	Color	Certifications	Dimmable	Voltage	Lumens	Working Hours	CRI
E2-DL-SLIM-4Inch-9W-27/30/35/40/50K-E G2	9W	2700K/ 3000K/	ETL & Energy Star	Tri Dimming & 1-10V	120-277V	639-1278lm	50,000	80
E2-DL-SLIM-6Inch-9/16/18W-27/30/35/40/50K-E G2	9/16/18W	3500K/ 4000K/						
E2-DL-SLIM-8Inch-9/16/18W-27/30/35/40/50K-E G2	9/16/18W	5000K						

Wiring Diagram

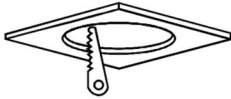
Fig.1  **Hole-Cut size**
 4" Opening \varnothing 4" (\varnothing 101mm)
 6" Opening \varnothing 6 5/8" (\varnothing 168mm)
 8" Opening \varnothing 8 1/4" (\varnothing 208mm)

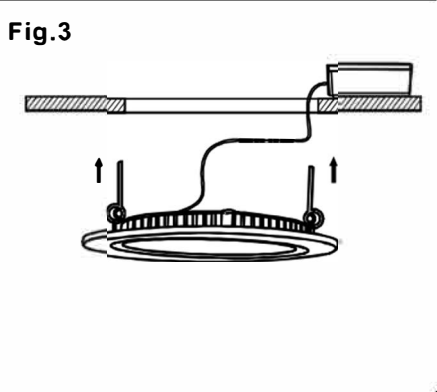
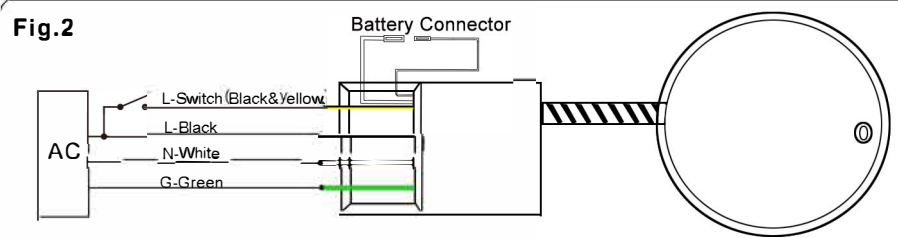

CAUTIONS:
 Please read this manual carefully before installing emergency panel.
 Please turn off AC power before rewiring and installation.
Ensure that L and N of the panel are properly connected to L and N of the AC power supply! 

AC Operation



1. LED Indicator on when EBBU Mode
2. LED Indicator Slow flicker when Charging
3. LED Indicator quick flicker when EBBU issue (self-inspection function)
4. Press down the test button, turn to EBBU Mode
Release the Test Button, Turn To AC Mode

 **When using electrical equipment, basic safety precautions should always be followed including the following:**

READ AND FOLLOW ALL SAFETY INSTRUCTIONS.

1. After getting the lamp, do not hurry to install it. Please read the installation and use safety instructions, and install and use the lamp according to the instructions.
2. Before installing, make certain the AC power to the fixture is off.
3. Do not use outdoors.
4. Do not let the lamp touch hot surfaces.
5. Do not mount near gas or electric heaters.
6. Repairs and maintenance must be carried out by qualified personnel
7. In this reminder, do not frequently switch the power supply when the lamp is in use. Since the lamp is frequently started at all times, the current is passed through the light source, Higher than normal working current, making the light source heating violently, thus reducing the service life.

 **WARNING: RISK OF SHOCK** , House electric current can cause painful shock or serious injury unless handled properly .

CAUTION: Turn off the main power at the circuit breaker before installing ,in order to prevent possible shock