

# LED SHOE BOX PARKING LIGHT

Model: E2-SB-G4-XXW-50K

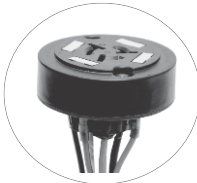

Motion Sensor



3/5/7 Pin photocell

## PRODUCT DESCRIPTION:

The E2 Lighting LED Shoe Box Parking Light is the ideal LED solution well-suited for distributing light in parking lots, streets and wall areas. Adjustable installation angles from -90~+90° with adjustable-fitter mount (other mounts available). Uses high-efficiency LM-80 LED chips to produce over 150 lm/W. Standard finish is dark bronze powder finish. ETL classified/recognized, ETL listed, DLC\* listed and RoHs compliant.

## FEATURES:

- Module lens design provides for well-suited lighting distribution
- LM-80 LEDs 150 lm/w+ Chip, Sosen driver
- Installation angle -90~+90 deg is adjustable
- Photocell sensor, Motion sensor option available
- ETL and DLC® Standard 5.1\*
- L70 lifespan projected to be 100,000 hours
- 5 year limited warranty

## APPLICATION:

- Outdoor Pole/Arm-Mounted Area and Roadway Luminaires
- Architectural, Industrial, Factory, Gym, Garden, Seaport, etc.

## TESTED DATA:

- Technical requirements Version: 5.1\*
- Classification: Standard/Premium\*
- Light Output: 7200 lm, 12,000 lm, 15,000 lm, 22,500 lm, 30,000 lm, 45,000 lm
- Wattage: 48W, 80W, 100W, 150W, 200W, 300W
- Efficacy: >150+ lm/W
- Power Factor: >0.9
- CCT: 3000K, 4000K, 5000K
- THD: <20 %
- Frequency: 50-60Hz
- Input Voltage: AC100-277V, 180-480V
- IP Rating: IP65
- Working Environment: -40°F-122°F
- Beam Angle: Type III, V
- Dimming Compatible: Yes
- Mercury Content: No Hg
- Lens: Polycarbonate
- \*3000K - 5000K Models DLC Listed\*

Product Number	Wattage	Color	Certifications	Dimmable	Voltage	Lumens	L70	Sensor
E2-SB-G4-48W-50K	48W	3000K = 30K 4000K = 40K 5000K = 50K	ETL & DLC®* Standard Premium	Option:Yes	AC100-277V AC180-480V	7200 lm	100,000hrs	P =Photocell MS- Motion sensor
E2-SB-G4-80W-50K	80W					12,000 lm		
E2-SB-G4-100W-50K	100W					15,000 lm		

E2-SB-G4-150W-50K	150W	3000K = 30K 4000K = 40K 5000K = 50K	ETL & DLC®* Standard Premium	Option:Yes	AC100-277V AC180-480V	22,500 lm	100,000hrs	P =Photocell MS- Motion sensor
E2-SB-G4-200W-50K	200W					30,000 lm		
E2-SB-G4-300W-50K	300W					45,000 lm		

Dimension: mm

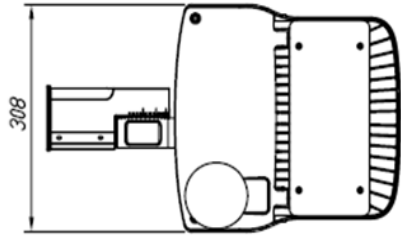

**For Models:**

E2-SB-G4-48W-50K

E2-SB-G4-80W-50K

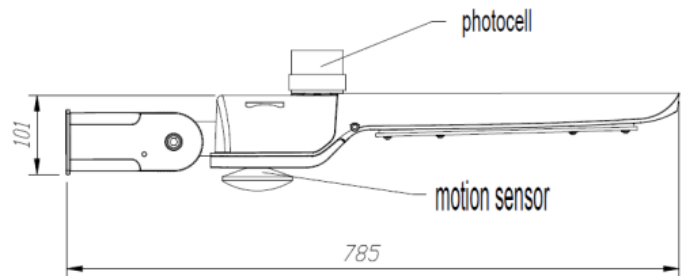
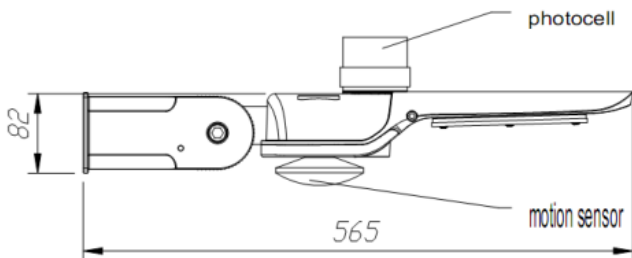
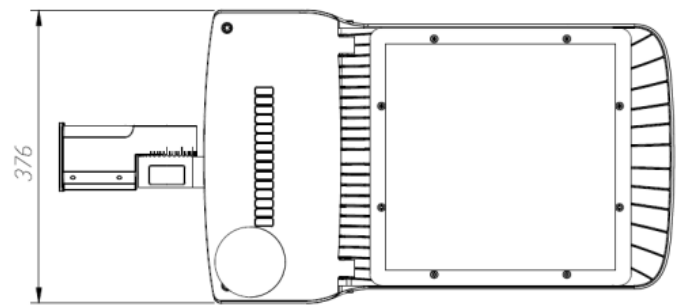
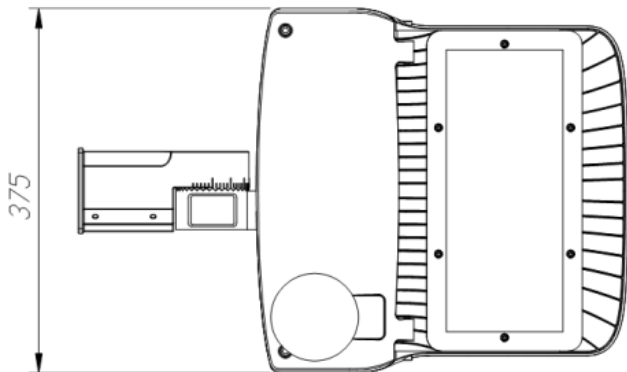
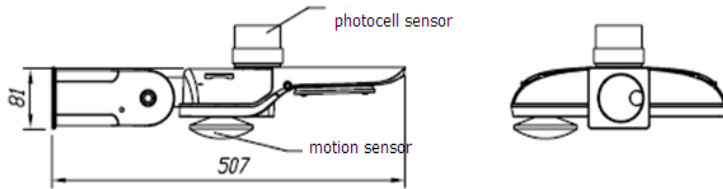

**For Models:**

E2-SB-G4-100W-50K

E2-SB-G4-150W-50K

**For Models:**

E2-SB-G4-200W-50K

E2-SB-G4-300W-50K

Dimension (Suitable for 2 3/8"/60mm diameter)

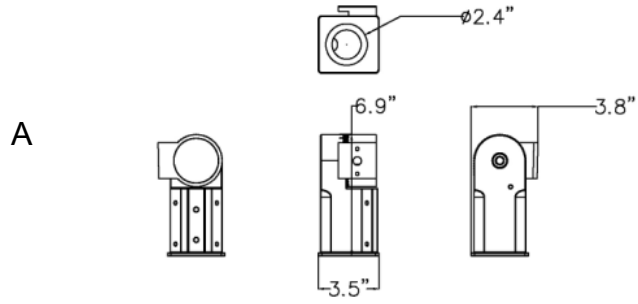

Slip fitter

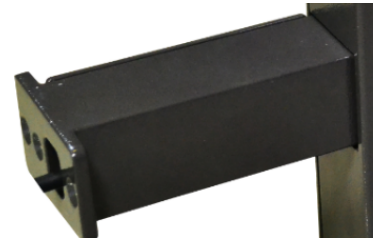
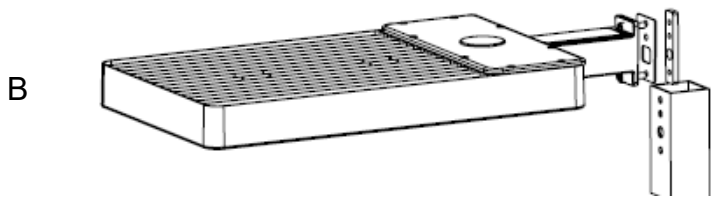

Square Pole

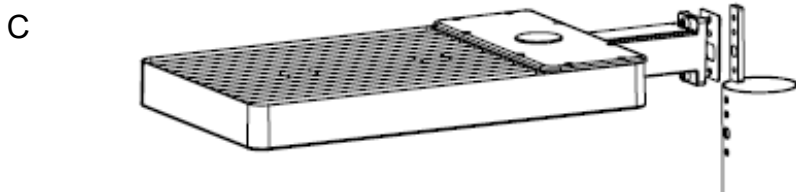

Round Pole

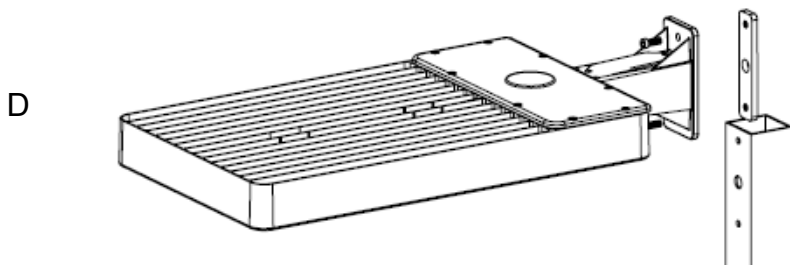

Square Pole

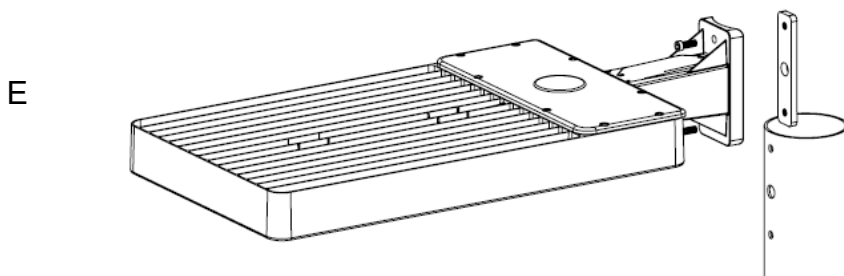

Round Pole

Dimension (Suitable for 3"/76mm diameter)

